

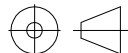



Palen vertikaal plaatsen en fixeren.
Daarvoor kan het dakhout gebruikt worden.
De exacte positie's en het type paal staan vermeld in het palenplan.

BEH. _									
ONDERDEEL									
Topvision opzettekening									
MM		GET.				SCHAAL	FORMAAT	DAT.	TEK.NR.
		DB				1:25	A3	17-01-'14	01
www.woodvision.nl  Woodvislon TUINHOUT								ARTIKELNUMMER	
								-	
								OPDRACHTGEVER	
-									



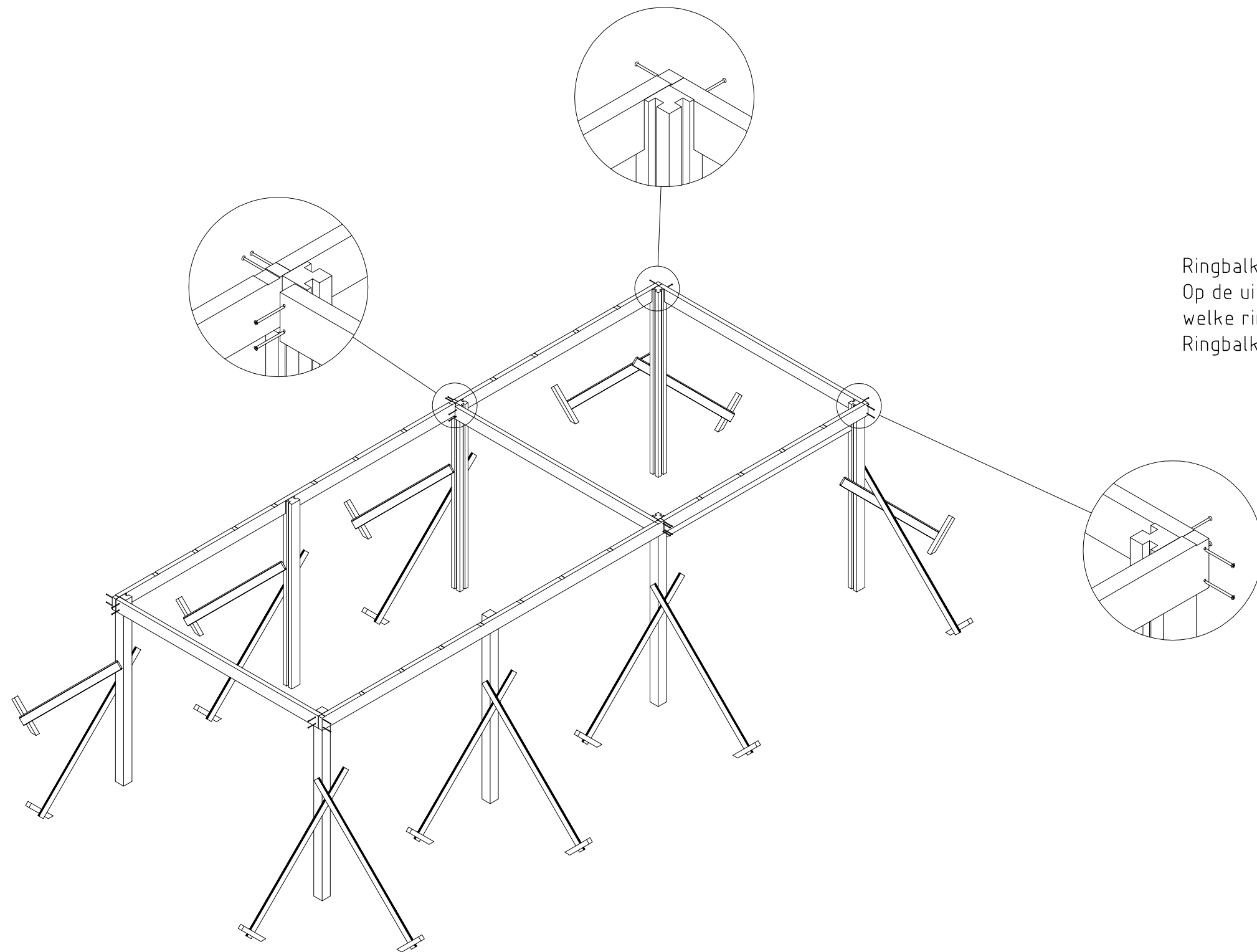
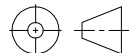

Ringbalken monteren.
Op de uittrekstaat en de tekening kunt u bepalen
welke ringbalk waar moet komen.
Ringbalken vastschroeven met gebitschroeven 8x100.

BEH. _									
ONDERDEEL									
Topvision opzettekening									
MM		GET.			SCHAAL	FORMAAT	DAT.	TEK.NR.	
		DB			1:50	A3	17-01-'14	02	
www.woodvision.nl							 Woodvislon TUINHOUT		
ARTIKELNUMMER									
-									
OPDRACHTGEVER									
-									

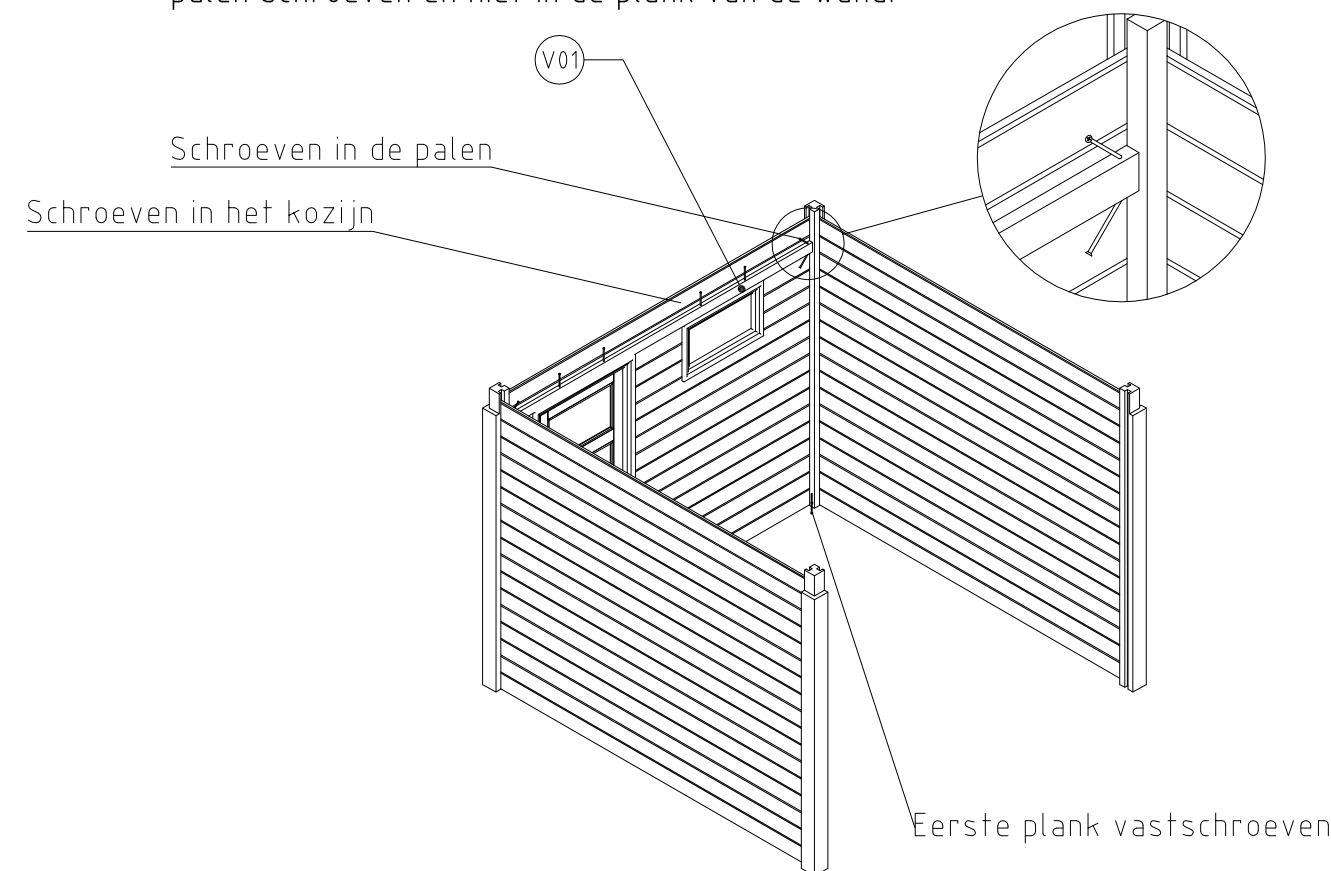
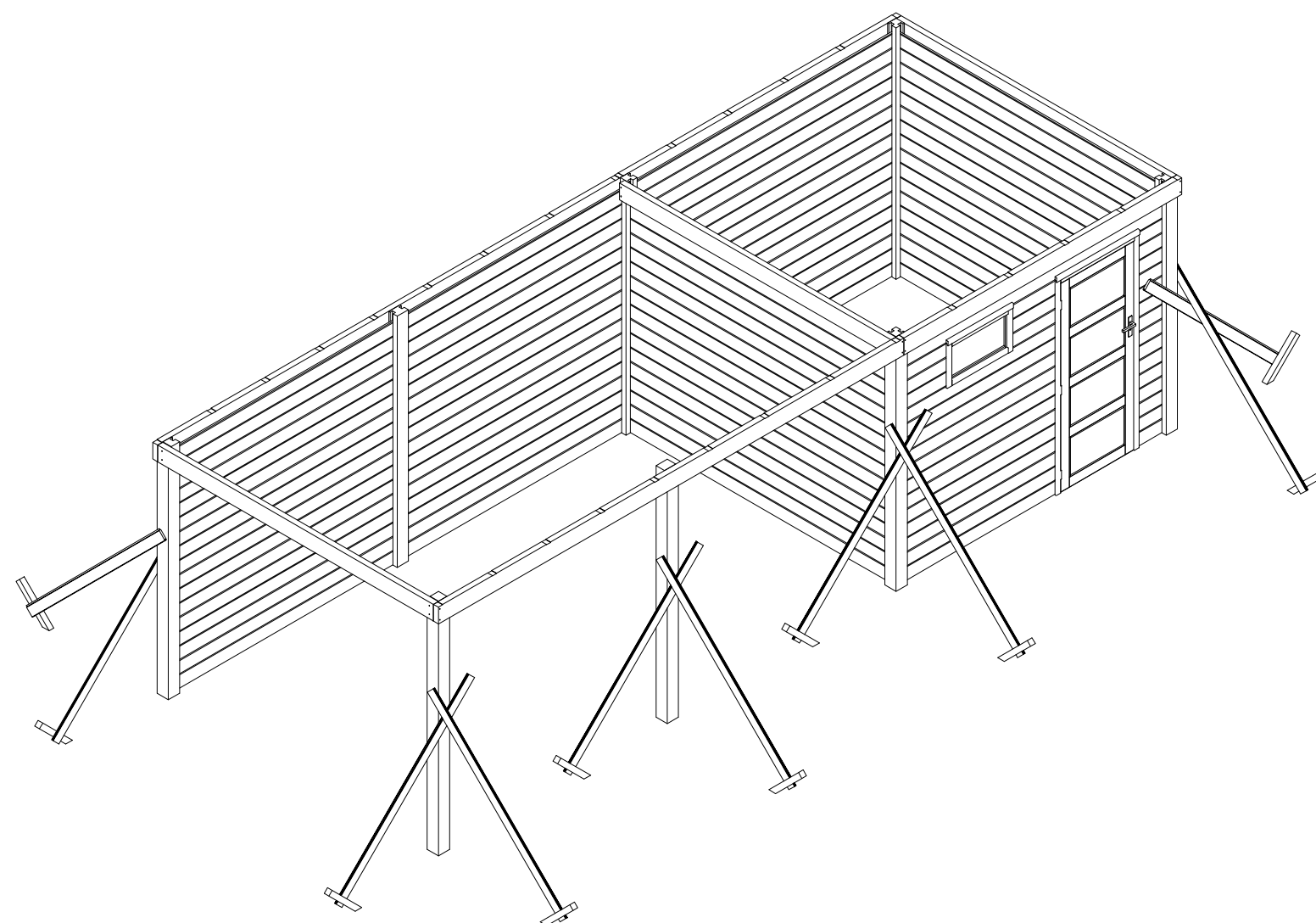

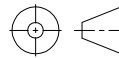
Schuif de planken van de wanden in de sponningen van de palen
Schroef de onderste plank vast aan de paal.
De rest van de planken niet vastschroeven ivm de werking van het hout.
Verstevigingsbalk (27x80) boven de kozijnen aanbrengen en
vastschroeven met schroeven 5x100. Alleen in de kozijnen en de
palen schroeven en niet in de plank van de wand.



BEH. _									
ONDERDEEL									
Topvision opzettekening									
MM		GET.			SCHAAL	FORMAAT	DAT.	TEK.NR.	
		DB			1:50	A3	17-01-'14	03	
www.woodvision.nl							 Woodvislon TUINHOUT		
ARTIKELNUMMER									
-									
OPDRACHTGEVER									
-									

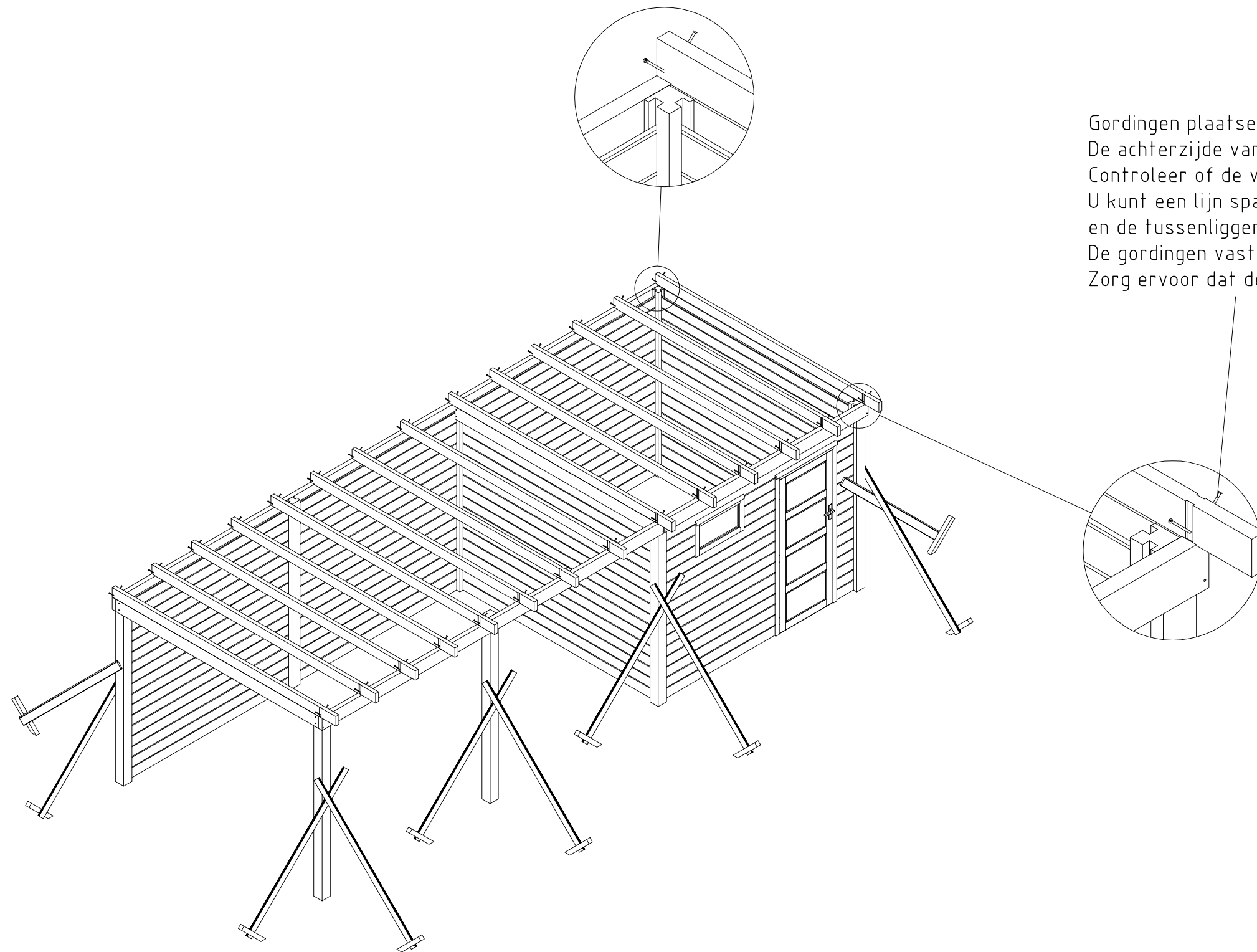

Gordingen plaatsen.
 De achterzijde van de gordingen gelijk houden met de ringbalk.
 Controleer of de voorkant van de gordingen in 1 lijn liggen.
 U kunt een lijn spannen tussen de eerste en de laatste gording
 en de tussenliggende gordingen controleren.
 De gordingen vastschroeven met schroeven 4x70.
 Zorg ervoor dat de schroeven aan de voorzijde geheel in de spouwing zit.



BEH. _									
ONDERDEEL									
Topvision opzettekening									
MM		GET.			SCHAAL	FORMAAT	DAT.	TEK.NR.	
		DB			1:50	A3	17-01-'14	04	
www.woodvision.nl							 Woodvislon TUINHOUT		
ARTIKELNUMMER									
-									
OPDRACHTGEVER									
-									

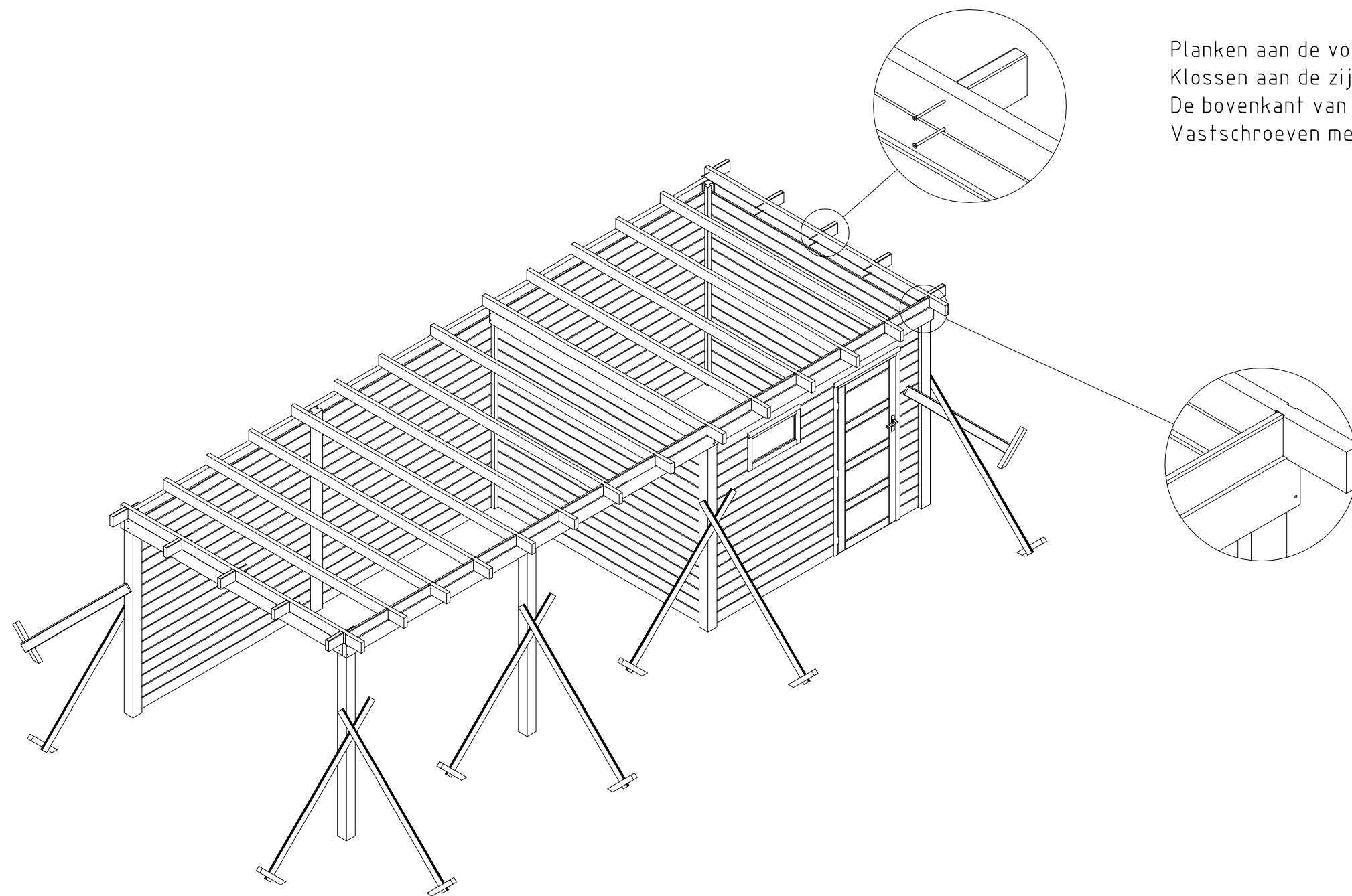

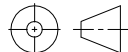
Planken aan de voorzijde tussen de gordingen plaatsen.
Klossen aan de zijkant plaatsen.
De bovenkant van de klossen gelijk aan de bovenkant van de gording.
Vastschroeven met schroeven 5x100.



BEH. _									
ONDERDEEL									
Topvision opzettekening									
MM		GET.			SCHAAL	FORMAAT	DAT.	TEK.NR.	
		DB			1:50	A3	17-01-'14	05	
www.woodvision.nl							 Woodvislon TUINHOUT		
ARTIKELNUMMER									
-									
OPDRACHTGEVER									
-									

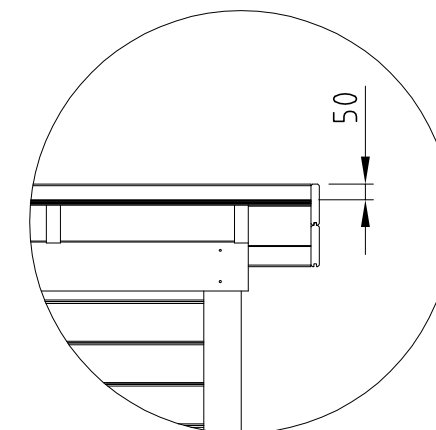
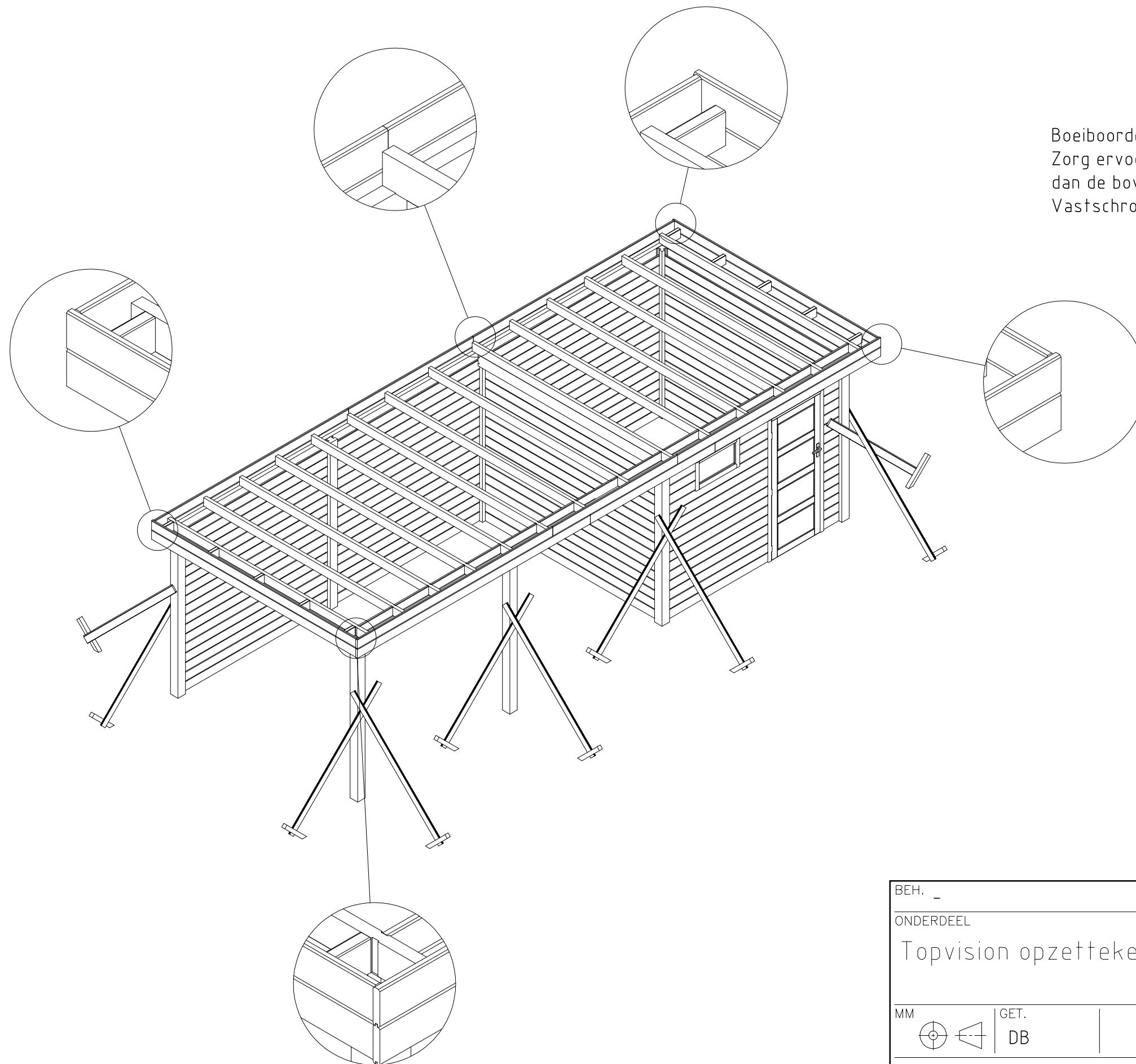

Boeiboorden plaatsen.
Zorg ervoor dat de bovenkant van de boeiboord 50 mm hoger ligt dan de bovenkant van de gordingen.
Vastschroeven met schroeven 4x70.

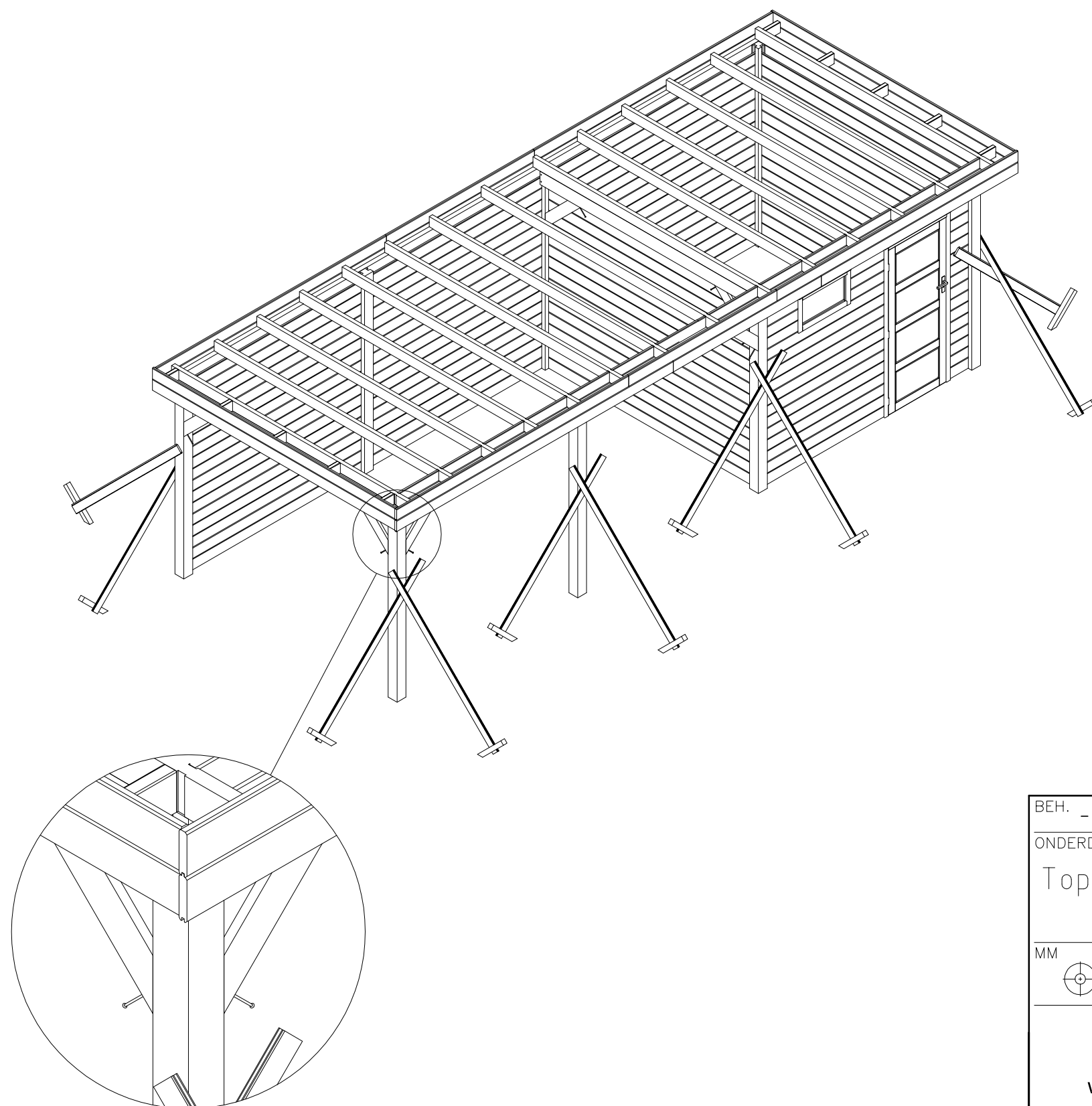

BEH. _									
ONDERDEEL									
Topvision opzettekening									
MM		GET.			SCHAAL	FORMAAT	DAT.	TEK.NR.	
		DB			1:50	A3	17-01-'14	06	
www.woodvision.nl							 Woodvislon TUINHOUT		
ARTIKELNUMMER									
-									
OPDRACHTGEVER									
-									

Schoren plaatsen.
Vastschroeven met schroeven 4x70.



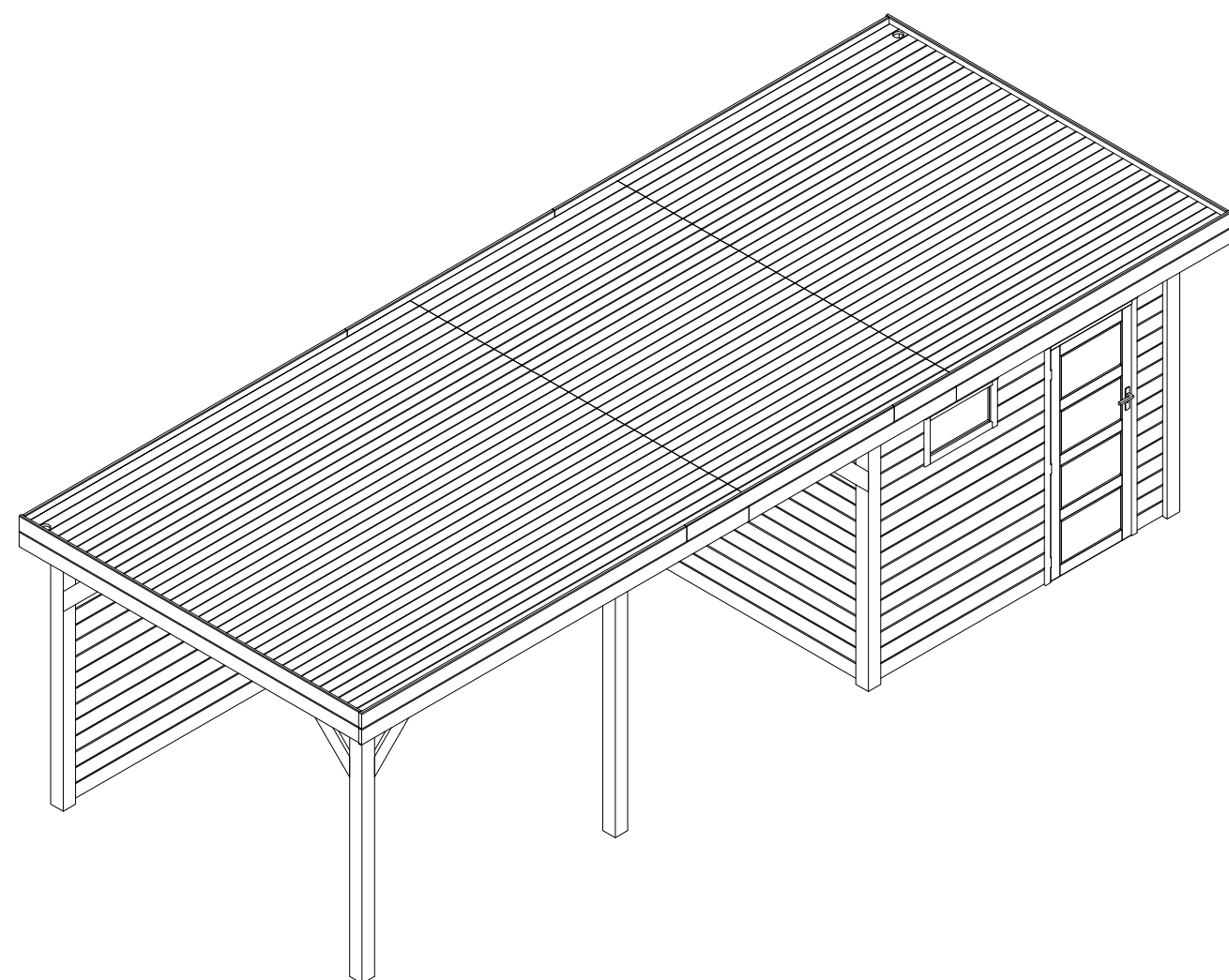

BEH. _									
ONDERDEEL									
Topvision opzettekening									
MM		GET.			SCHAAL	FORMAAT	DAT.	TEK.NR.	
		DB			1:50	A3	17-01-'14	07	
www.woodvision.nl							 Woodvislon TUINHOUT		
ARTIKELNUMMER									
-									
OPDRACHTGEVER									
-									

Hulpschoren verwijderen.
Dakhout plaatsen. Vastzetten met 2 spijkers per plank.

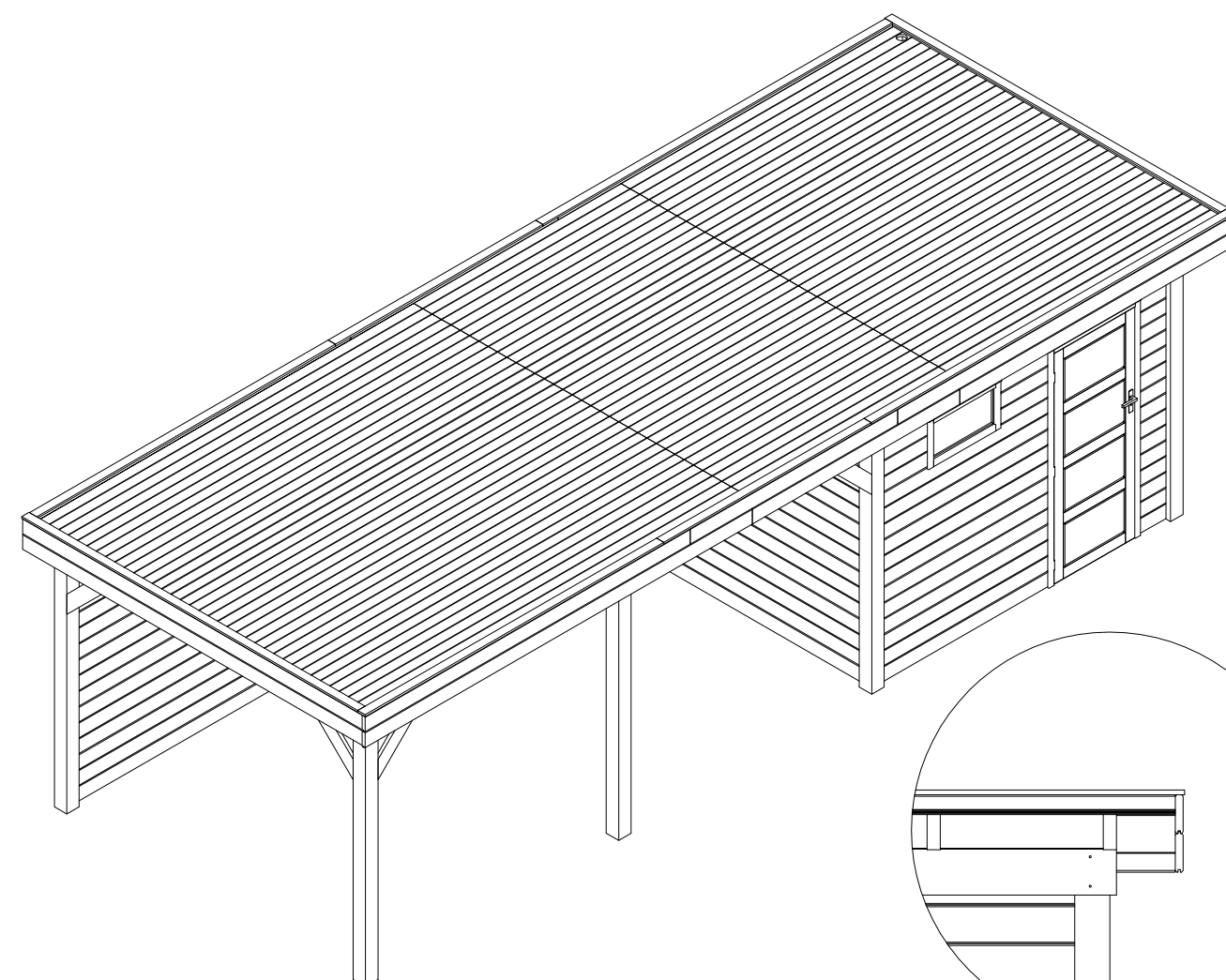

Afdekljst bovenop de boeiboord plaatsen
Vastzetten met schroef 4x70.

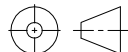

BEH. _									
ONDERDEEL									
Topvision opzettekening									
MM		GET.			SCHAAL	FORMAAT	DAT.	TEK.NR.	
		DB			1:50	A3	17-01-'14	08	
www.woodvision.nl							 Woodvislon TUINHOUT		
ARTIKELNUMMER									
-									
OPDRACHTGEVER									
-									